

TMIP
 TMIP 7-28 - d 7-28mm
 TMIP 30-60 - d 30-60mm
 TMIP 7-60 - d 7-60mm

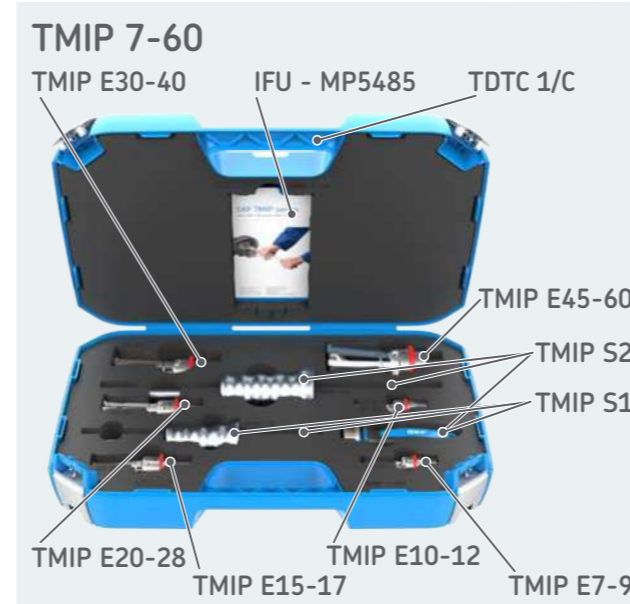

	TMIP E7-9	TMIP E10-12	TMIP E15-17	TMIP E20-28	TMIP E30-40	TMIP E45-60
d - D (mm)	7 - 9	10 - 12	15 - 17	20 - 28	30 - 40	45 - 60
d - D (in.)	0.28 - 0.35	0.39 - 0.47	0.59 - 0.67	0.79 - 1.1	1.2 - 1.6	1.8 - 2.4
60..	607 - 609	6000 - 6001	6002 - 6003	6004 - 6005	6006 - 6008	6009 - 6012
62..	627 - 629	6200 - 6201	6202 - 6203	6204 - 62/28	6206 - 6208	6209 - 6212
63..		6300 - 6301	6302 - 6303	6304 - 63/28	6306 - 6308	6309 - 6312
64..			6403	6404 - 6405	6406 - 6408	6409 - 6412
16...		16100 - 16001	16002 - 16003	16004 - 16005	16006 - 16008	16009 - 16012
61...	618/7 - 619/9	61800 - 61901	61802 - 61903	61704 - 61905	61706 - 61908	61709 - 61912
1... 2...	127 - 129	1200 - 1301	1202 - 1303	1204 - 1305	1206 - 1308	1209 - 1312
32.. 33..		3200 - 3201	3202 - 3203	3204 - 3205	3206 - 3208	3209 - 3212
42.. 43..		4200 - 4201 4301	4202 - 4203 4302 - 4303	4204 - 4205 4304 - 4305	4206 - 4208 4306 - 4308	4209 - 4212 4309 - 4312
213.. 223..					22205/20 - 22305	21306 - 22308 21309 - 22312

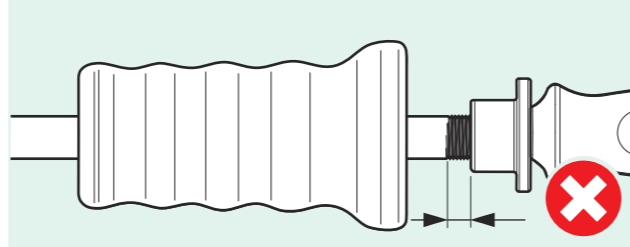
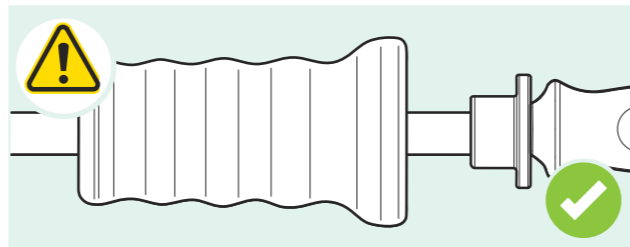
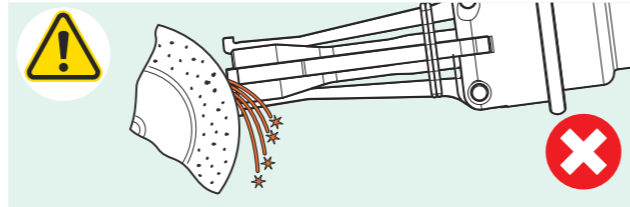
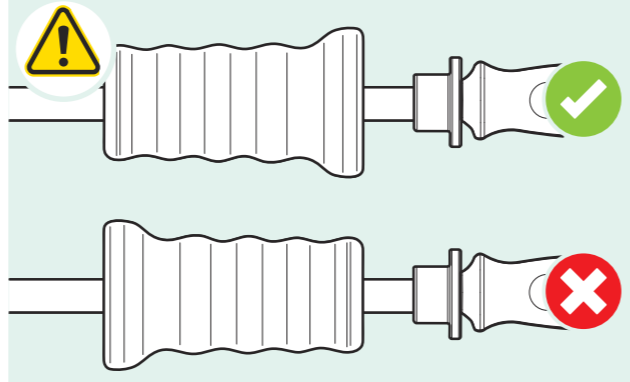
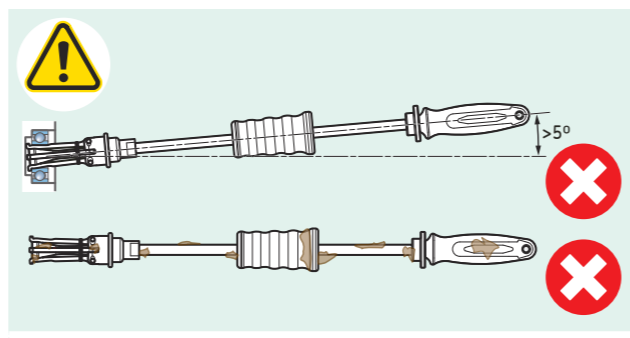
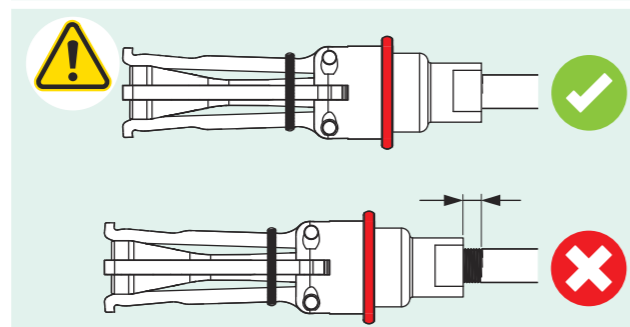
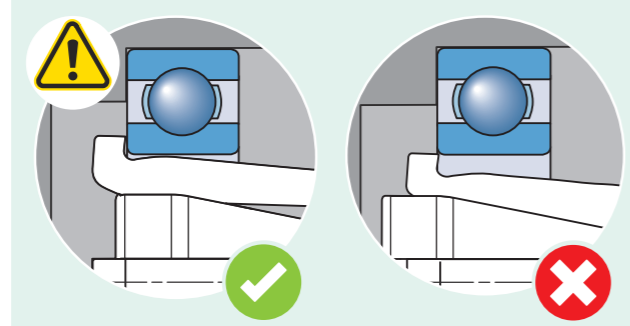
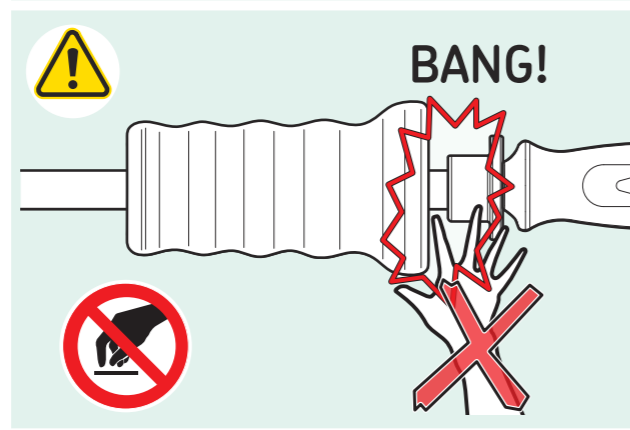
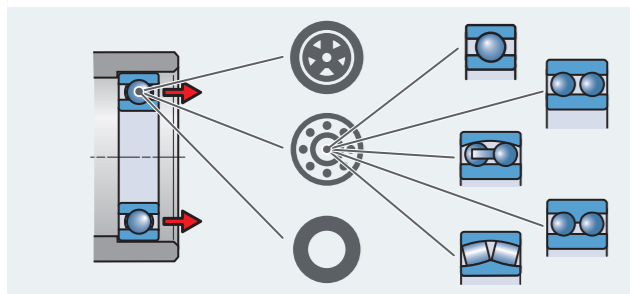
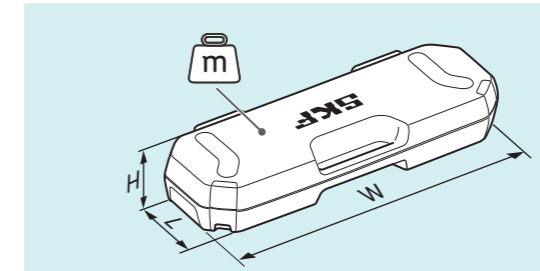

	TMIP 7-28	TMIP 30-60	TMIP 7-60
m	kg 3.1 lb 6.8	5.4 11.8	9.4 20.7
W	mm 530 in. 20.9	530 20.9	530 20.9
L	mm 180 in. 7.0	180 7.0	360 14.2
H	mm 85 in. 3.4	85 3.4	110 4.3

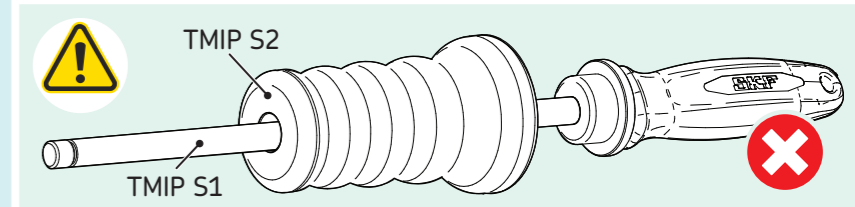
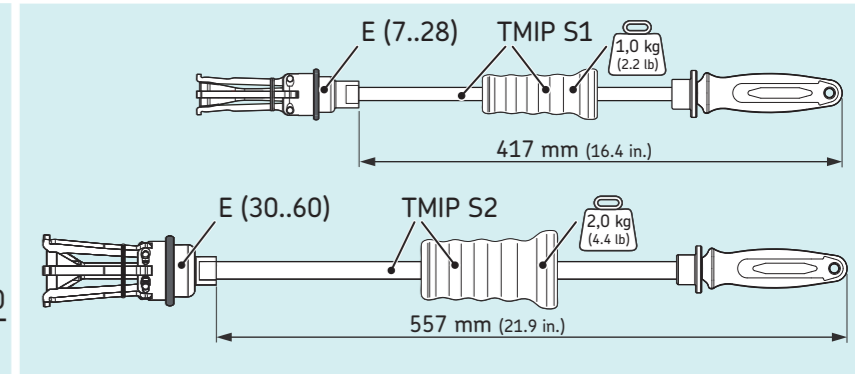

SKF TMIP series

TMIP 7-28 | TMIP 30-60 | TMIP 7-60



Instructions for use
Bedienungsanleitung
Instrucciones de uso
Mode d'emploi

Manuale d'istruzioni
Instruções de uso
Инструкция по эксплуатации
使用说明书

TMIP 7-28 & TMIP 7-60

TMIP E7-9

TMIP E15-17

TMIP E10-12

TMIP E20-28

TMIP S1

TMIP 30-60 & TMIP 7-60

TMIP E30-40

TMIP S2

TMIP E45-60

TMIP 7-28-CX

TDTC 1/C

TMIP 30-60-CX

E	d - D		A _{max}		L _{max}	
	mm	in.	mm	in.	mm	in.
TMIP E7-9	7 - 9	0.28 - 0.35	6	0.24	39	1.5
TMIP E10-12	10 - 12	0.39 - 0.47	6	0.24	45	1.8
TMIP E15-17	15 - 17	0.59 - 0.67	7.5	0.29	55	2.2
TMIP E20-28	20 - 28	0.79 - 1.1	10	0.4	60	2.4
TMIP E30-40	30 - 40	1.2 - 1.6	11.5	0.45	97	3.8
TMIP E45-60	45 - 60	1.8 - 2.4	15	0.6	102	4.0

E	H		G		AF	
	mm	in.	mm	in.	mm	in.
TMIP E7-9	10	0.4	91	3.6		
TMIP E10-12	11	0.4	91	3.6	15	19/32"
TMIP E15-17	18	0.7	118	4.6		
TMIP E20-28	24	0.9	127	5.0		
TMIP E30-40	>35	>1.4	143	5.6	19	3/4"
TMIP E45-60	>64	>2.5	155	6.1		

	TMIP 7-28	TMIP 30-60	TMIP 7-60
TMIP E7-9	✓	✗	✓
TMIP E10-12	✓	✗	✓
TMIP E15-17	✓	✗	✓
TMIP E20-28	✓	✗	✓
TMIP E30-40	✗	✓	✓
TMIP E45-60	✗	✓	✓
TMIP S1	✓	✗	✓
TMIP S2	✗	✓	✓

1

d - D (mm)	7 - 9	10 - 12	15 - 17	20 - 28	30 - 40	45 - 60
60	607-609	6000-6001	6002-6003	6004	6005	6006-6008
62	627-629	6200-6201	6202-6203	6204	6205	6206-6208
63		6300-6301	6302-6303	6304	6305	6306-6308
64			6403	6404	6405	6406-6408
66			6600-6601	6602-6603	6604	6606-6608
68			6800-6801	6802-6803	6804	6806-6808
70			7000-7001	7002-7003	7004	7006-7008
72			7200-7201	7202-7203	7204	7206-7208
74			7400-7401	7402-7403	7404	7406-7408
76			7600-7601	7602-7603	7604	7606-7608
78			7800-7801	7802-7803	7804	7806-7808
80			8000-8001	8002-8003	8004	8006-8008
82			8200-8201	8202-8203	8204	8206-8208
84			8400-8401	8402-8403	8404	8406-8408
86			8600-8601	8602-8603	8604	8606-8608
88			8800-8801	8802-8803	8804	8806-8808
90			9000-9001	9002-9003	9004	9006-9008
92			9200-9201	9202-9203	9204	9206-9208
94			9400-9401	9402-9403	9404	9406-9408
96			9600-9601	9602-9603	9604	9606-9608
98			9800-9801	9802-9803	9804	9806-9808
100			10000-10001	10002-10003	10004	10006-10008

2

TMIP E7-9
TMIP E10-12
TMIP E15-17
TMIP E20-28

TMIP S1

TMIP S2

TMIP E30-40
TMIP E45-60

TMIP S2

3

TMIP 7-60
TMIP 30-60

4

5

d_{min}

6

7

CLICK!

8

BANG!
BANG!
BANG!

The contents of this publication are the copyright of the publisher and may not be reproduced (even extracts) unless prior written permission is granted. Every care has been taken to ensure the accuracy of the information contained in this publication but no liability can be accepted for any loss or damage whether direct, indirect or consequential arising out of the use of the information contained herein.

Nachdruck, auch auszugsweise, nur mit unserer vorherigen schriftlichen Genehmigung gestattet. Die Angaben in dieser Druckschrift wurden mit größter Sorgfalt auf ihre Richtigkeit hin überprüft. Trotzdem kann keine Haftung für Verluste oder Schäden irgendwelcher Art übernommen werden, die sich mittelbar oder unmittelbar aus der Verwendung der hier enthaltenen Informationen ergeben.

El contenido de esta publicación es propiedad de los editores y no puede reproducirse (incluso parcialmente) sin autorización previa por escrito. Se ha tenido el máximo cuidado para garantizar la exactitud de la información contenida en esta publicación, pero no se acepta ninguna responsabilidad por pérdidas o daños, ya sean directos, indirectos o consecuentes, que se produzcan como resultado del uso de dicha información.

Le contenu de cette publication est soumis au copyright de l'éditeur et sa reproduction, même partielle, est interdite sans autorisation écrite préalable. Le plus grand soin a été apporté à l'exactitude des informations données dans cette publication mais SKF décline toute responsabilité pour les pertes ou dommages directs ou indirects découlant de l'utilisation du contenu du présent document.

La riproduzione, anche parziale, del contenuto di questa pubblicazione è consentita soltanto previa autorizzazione scritta della SKF. Nella stesura è stata dedicata la massima attenzione al fine di assicurare l'accuratezza dei dati, tuttavia non si possono accettare responsabilità per eventuali errori od omissioni, nonché per danni o perdite diretti o indiretti derivanti dall'uso delle informazioni qui contenute.

O conteúdo desta publicação é de direito autoral do editor e não pode ser reproduzido (nem mesmo parcialmente), a não ser com permissão prévia por escrito. Todo cuidado foi tomado para assegurar a precisão das informações contidas nesta publicação, mas nenhuma responsabilidade pode ser aceita por qualquer perda ou dano, seja direto, indireto ou consequente como resultado do uso das informações aqui contidas.

Содержание этой публикации является собственностью издателя и не может быть воспроизведено (даже частично) без предварительного письменного разрешения. Несмотря на то, что были приняты все меры по обеспечению точности информации, содержащейся в настоящем издании, издатель не несет ответственности за любой ущерб, прямой или косвенный, вытекающий из использования вышеуказанной информации.

本出版物内容的著作权归出版者所有且未经事先书面许可不得被复制（甚至引用）。我们已采取了一切注意措施以确定本出版物包含的信息准确无误，但我们不对因使用此等信息而产生的任何损失或损害承担任何责任，不论此等责任是直接、间接或附随性的。

skf.com | mapro.skf.com | skf.com/mount

© SKF is a registered trademark of the SKF Group.
© SKF Group 2020
MP5485 · 2020/07

8

9

10

11